

## INSTRUCTION MANUAL

VHF BRS TRANSCEIVER

**IC-F11BR**

UHF BRS TRANSCEIVER

**IC-F21BR**

This device complies with Part 15 of the FCC rules. Operation is subject to the following two conditions: (1) This device may not cause harmful interference, and (2) this device must accept any interference received, including interference that may cause undesired operation.

**Icom Inc.**

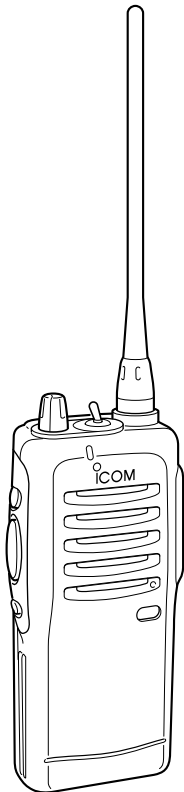

---

## SAFETY TRAINING INFORMATION



Your Icom radio generates RF electromagnetic energy during transmit mode. This radio is designed for and classified as “Occupational Use Only”, meaning it must be used only during the course of employment by individuals aware of the hazards, and the ways to minimize such hazards.

**This radio is NOT intended for use by the “General Population” in an uncontrolled environment.**

This radio has been tested and complies with the FCC RF exposure limits for “Occupational Use Only”. In addition, your Icom radio complies with the following Standards and Guidelines with regard to RF energy and electromagnetic energy levels and evaluation of such levels for exposure to humans:

- FCC OET Bulletin 65 Edition 97-01 Supplement C, Evaluating Compliance with FCC Guidelines for Human Exposure to Radio Frequency Electromagnetic Fields.
- American National Standards Institute (C95.1 – 1992), IEEE Standard for Safety Levels with Respect to Human Exposure to Radio Frequency Electromagnetic Fields, 3 kHz to 300 GHz.
- American National Standards Institute (C95.3 – 1992), IEEE Recommended Practice for the Measurement of Potentially Hazardous Electromagnetic Fields – RF and Microwave.



**To ensure that your exposure to RF electromagnetic energy is within the FCC allowable limits for occupational use, always adhere to the following guidelines:**

- **DO NOT** operate the radio without a proper antenna attached, as this may damage the radio and may also cause you to exceed FCC RF exposure limits. A proper antenna is the antenna supplied with

---

this radio by the manufacturer or an antenna specifically authorized by the manufacturer for use with this radio.

- **DO NOT** transmit for more than 50% of total radio use time (“50% duty cycle”). Transmitting more than 50% of the time can cause FCC RF exposure compliance requirements to be exceeded. The radio is transmitting when the “TX indicator” lights red. You can cause the radio to transmit by pressing the “PTT” switch.
- **ALWAYS use** Icom authorized accessories (antennas, batteries, belt clips, speaker/mics, etc). Use of unauthorized accessories can cause the FCC RF exposure compliance requirements to be exceeded.
- **ALWAYS keep** the antenna at least 2.5 cm (1 inch) away from the body when transmitting and only use the Icom belt-clips, listed in p. 22, when attaching the radio to your belt, etc., to ensure FCC RF exposure compliance requirements are not exceeded. To provide the recipients of your transmission the best sound quality, hold the antenna at least 5 cm (2 inches) from your mouth, and slightly off to one side.

The information listed above provides the user with the information needed to make him or her aware of RF exposure, and what to do to assure that this radio operates within the FCC RF exposure limits of this radio.

## **Electromagnetic Interference/Compatibility**

During transmissions, your Icom radio generates RF energy that can possibly cause interference with other devices or systems. To avoid such interference, turn off the radio in areas where signs are posted to do so. **DO NOT** operate the transmitter in areas that are sensitive to electromagnetic radiation such as hospitals, aircraft, and blasting sites.

---

**Your Icom IC-F21BR (UHF) operates on GMRS (Plus 7 frequencies shared with FRS) and BRS frequencies. Select the frequencies you desire from the Frequency Table and assign them to channel 1 or channel 2.**

## **GENERAL MOBILE RADIO SERVICE (GMRS);**

Frequency Table Numbers **3 -17**

GMRS is a two-way personal radio service available to an individual (one man or one woman) to facilitate the activities of the individual's immediate family members. GMRS is not authorized for business uses.

Users must cooperate in the selection and use of channels to make the most effective use of them and reduce the possibility of interference. 7 channels are compatible with FRS channels. You can communicate with any FRS radios on these 7 channels. FRS is a UHF two-way voice communication service for family, friends and associates to communicate among themselves within their neighbourhood and while on group outings. Eight GMRS channels are authorized for repeater operation\*.

You must obtain a license for a GMRS system. Application is made on FCC Form 605 or on line at <http://www.fcc.gov/wtb/uls>. As of January, 2001, the license fee is \$85 for a 5-year term. **Schedule F of the form permits immediate temporary operation** during the application process. Form 605 and Form 159 fee remittance advice, are available for downloading at <http://www.fcc.gov/formpage.html>.

Applications may also be mailed to Federal Communications Commission, Wireless Bureau Applications, PO Box 358245, Pittsburgh, PA 15251-5245

Call 1-800-418 FORM to have the forms mailed to you, or call 1-202-418-0177 from your fax machine to have them faxed to you on the FCC Fax-On-Demand system. For assistance completing the forms call 1-800-CALL-FCC.

\*Repeater use may require a subscription.

---

## **BUSINESS RADIO SERVICE (BRS);**

Frequency Table Numbers;

### **IC-F21BR (UHF): 1, 2, 18-36, IC-F11BR (VHF); 1-36**

BRS frequencies are a part of the FCC's Industrial/Business Pool for the operation of a commercial activity, or the operation of educational, philanthropic, ecclesiastical institutions or clergy activities, or the operation of hospitals, clinics, or medical associations.

The itinerant BRS frequencies in the IC-F11/F21BR are not designated for permanent use and need not be processed by a frequency coordinator. No protection is provided from interference from other itinerant operations.

You must obtain a license for a BRS system. Application for a BRS license is made on FCC Form 601 or on line at <http://www.fcc.gov/wtb/uls/> Universal Licensing System. As of January, 2001, the license fee is \$120 for a 10-year term. Forms 601 and 159 are available for downloading from the FCC's Internet homepage on the World Wide Web at <http://www.fcc.gov/form-page.html>.

Applications for BRS may be mailed to Federal Communications Commission, Wireless Bureau Applications, P.O. Box 358130, Pittsburgh, PA 15251-5130.

Before filling out your FCC Form 601 application Technical Data section, you must decide which frequency (or frequencies) you will operate on. See the frequency charts on pgs. 14 and 16.

Call 1-800-418 FORM to have the forms mailed to you, or call 1-202-418-0177 from your fax machine to have them faxed to you on the FCC Fax-On-Demand system.

---

## FOREWORD

---

Thank you for purchasing the IC-F11/F21BR FM transceiver.

**READ ALL INSTRUCTIONS** carefully and completely before using the transceiver.

**SAVE THIS INSTRUCTION MANUAL**—This instruction manual contains important operating instructions for the transceiver.

---

## IMPORTANT

---

⚠ **CAUTION! NEVER** hold the transceiver so that the antenna is very close to, or touching exposed parts of the body, especially the face or eyes, while transmitting. The transceiver will perform best if the microphone is 2 to 4 in. (5 to 10 cm) away from the lips and the transceiver is vertical.

⚠ **CAUTION! NEVER** operate the transceiver with a headset or other audio accessories at high volume levels.

⚠ **CAUTION! NEVER** short the terminals of the battery pack.

**DO NOT** push the PTT when not actually desiring to transmit.

**AVOID** using or placing the transceiver in direct sunlight or in areas with temperatures below  $-22^{\circ}\text{F}$  ( $-30^{\circ}\text{C}$ ) or above  $+140^{\circ}\text{F}$  ( $+60^{\circ}\text{C}$ ).

**DO NOT** modify the transceiver for any reason.

**KEEP** the transceiver from the heavy rain, and **Never** immerse it in water. The transceiver construction is **water resistant**, not water-proof.

The use of non-Icom battery packs/chargers may impair transceiver performance and invalidate the warranty.

***FCC caution:*** Changes or modifications to this transceiver, not expressly approved by Icom Inc., could void your authority to operate this transceiver under FCC regulations.

---

# TABLE OF CONTENTS

---

SAFETY TRAINING INFORMATION .....	i-ii
ABOUT GMRS and BRS .....	iii-iv
FOREWORD .....	v
IMPORTANT .....	v
TABLE OF CONTENTS .....	vi
<b>1 PANEL DESCRIPTION .....</b>	<b>1-3</b>
■ Switches, controls, keys and connectors .....	1-2
■ LED indicator .....	3
<b>2 ACCESSORIES .....</b>	<b>4</b>
<b>3 BATTERY PACKS .....</b>	<b>5-11</b>
■ Battery pack replacement .....	5
■ Battery cautions .....	6
■ Battery charging .....	7-9
■ Charging NOTE .....	10
■ Battery case (Option) .....	11
<b>4 SET MODE .....</b>	<b>12-20</b>
■ Set mode .....	12
◇ Set the operation Frq. for IC-F11BR .....	13
◇ Set the operation Frq. for IC-F21BR .....	15
<b>5 OPERATION .....</b>	<b>21-23</b>
■ Receiving and transmitting .....	21
■ Setting squelch level .....	23
■ Wide/Narrow selection .....	23
<b>6 OPTION .....</b>	<b>24-25</b>

Icom, Icom Inc. and the  logo are registered trademarks of Icom Incorporated (Japan) in the United states, the United Kingdom, Germany, France, Spain, Russia and/or other countries.

# 1 PANEL DESCRIPTION

## ■ Switches, controls, keys and connectors

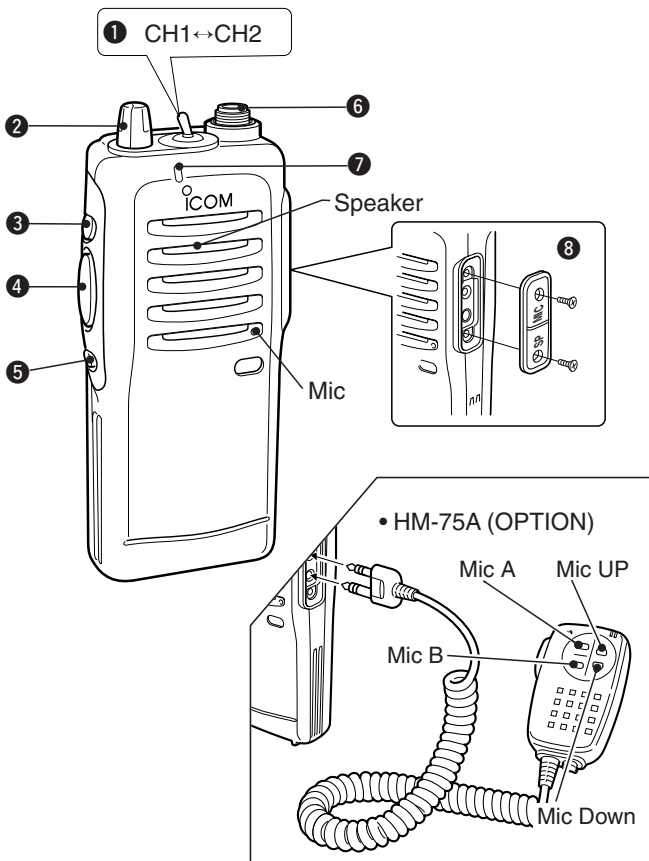



**1 CHANNEL SELECTOR/SW [CH]**

Toggle the CH switch to select CH1 or CH2.

**2 VOLUME CONTROL [OFF/VOL]**

Turns power ON and adjusts the audio level.

**3 MONITOR (Audi) key [MONI] (p. 22)**

- Push and hold to open the noise/tone squelch.
- Push to turn the noise/tone squelch ON.

**4 PTT SWITCH [PTT]**

Push and hold to transmit; release to receive.

**5 WIDE/NARROW KEY [W/N] (p. 23)**

- Push to select Wide deviation.
- Push and hold to select Narrow deviation.

**6 ANTENNA CONNECTOR**

Connects the supplied antenna.

**7 TX/RX INDICATOR LED (p. 3)**

- Lights red while transmitting.
- Lights green while receiving a signal, or squelch is open.

**8 [SP]/[MIC] JACK**

Connects optional speaker-microphone.

**◇ HM-75A key reference (OPTION)\***

<b>Mic Up</b>	Same as [MONI(Audi)] key (p. 22)
<b>Mic Down</b>	Same as [W/N] key (p. 23)
<b>Mic A</b>	Push to select CH 1
<b>Mic B</b>	Push to select CH 2

\*These functions are available when the optional Speaker/Mic. is connected.

# 1 PANEL DESCRIPTION

## ■ LED indicator

The TX/RX indicator LED indicates informations several ways as follows;  
(Ref.: R=Red, G=Green)

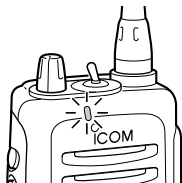

- TX: Turns Red while transmitting a signal.



- RX: Turns Green while receiving a signal.



- Low BATT1: You should charge the battery. (blinks slowly)



- Low BATT2: You must charge the battery. (blinks fast)

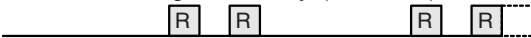

- TX low BATT1: Low BATT1 was detected during TX mode.



- TX low BATT2: Low BATT2 was detected during TX mode.



### CAUTION:

- Low BATT3: If you did not charge the battery after Low BATT2 warning has appeared, the Low BATT3 warning beep emits for 15 sec. then the power turns OFF automatically.

## ■ Accessory attachment

### ◇ Supplied accessories

The transceiver comes supplied with the following accessories.

- ① Flexible antenna
- ② Belt clip

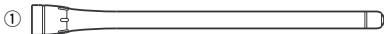

### ◇ Antenna

The antenna screws onto the transceiver as illustrated at right.

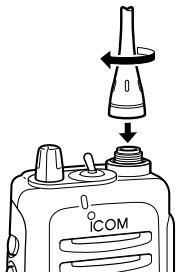

### ◇ Belt clip

Attach the belt clip to the transceiver as illustrated below.

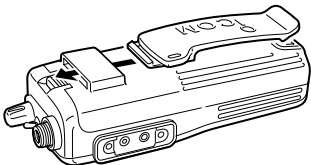
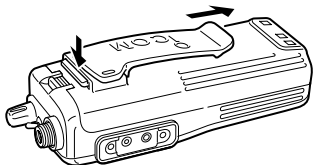

# 3 BATTERY PACKS

## ■ Battery pack replacement

Before replacing the battery pack, the volume control **MUST** be rotated fully counterclockwise, until a click is heard, to **turn the power OFF**.

- Push the battery release forward, then pull the battery pack upward with the transceiver facing you.

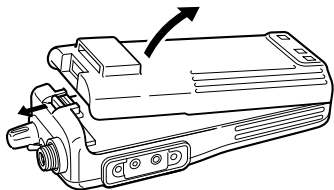

### ◇ BATTERY PACKS

Battery pack	Voltage	Capacity	Charging period		Operating period* <sup>1</sup>
			BC-146	BC-144, BC-119 or BC-121	
BP-208* <sup>2</sup>	Battery case for AA (R6) × 6 alkaline				
BP-209	7.2 V	1100 mAh	12 hrs	1.5 hrs	8 hrs
BP-210	7.2 V	1650 mAh	18.5 hrs	2.0 hrs	11 hrs
BP-222* <sup>3</sup>	7.2 V	600 mAh	6.5 hrs	1 hr	5.5* <sup>3</sup> hrs

\*<sup>1</sup> Operating periods are calculated under the following conditions;  
Tx : Rx : standby = 5 : 5 : 90

\*<sup>1</sup> Operating period depends on the alkaline cells used. (BP-208 only)

\*<sup>2</sup> Output power is automatically reduced to 1 W to retain sufficient power in case of an emergency, etc.

\*<sup>3</sup> Operating period measured with the 2 W model.

## ■ Battery cautions

- **CAUTION! NEVER** short the terminals of the battery pack (or charging terminals of the transceiver). Also, current may flow into nearby metal objects such as a necklace, so be careful when placing battery packs (or the transceiver) in handbags, etc. Simply carrying with or placing near metal objects such as a necklace, etc. causes shorting. This will damage not only the battery pack, but also the transceiver.
- **NEVER** incinerate used battery packs. Internal battery gas may cause an explosion.
- **NEVER** immerse the battery pack in water. If the battery pack becomes wet, be sure to wipe it dry **BEFORE** attaching it to the transceiver.
- **Clean** the battery terminals to avoid rust or miss contact.
- **Keep** battery contacts clean. It's a good idea to clean battery terminals once a week.

If your battery pack seems to have no capacity even after being charged, completely discharge them, then fully charge the battery pack again. If the battery pack still does not retain a charge (or only very little charge), a new battery pack must be purchased.

### ◇ Recycling information (U.S.A. only)



The battery (BP-209, BP-210 or BP-222) that you have purchased is recyclable. At the end of its life, under various state and local laws, it may be illegal to dispose of this battery into the municipal waste stream. Call 1-800-822-8837 for battery recycling options in your area or contact your dealer.

### 3 BATTERY PACKS

## ■ Battery charging

#### ◇ Rapid charging with the BC-144+AD-99

The optional BC-144 provides rapid charging of optional battery packs.

The following are additionally required:

- One AD-99 (depends on version.).
- An AC adaptor (may be supplied with the BC-144 depending on version).

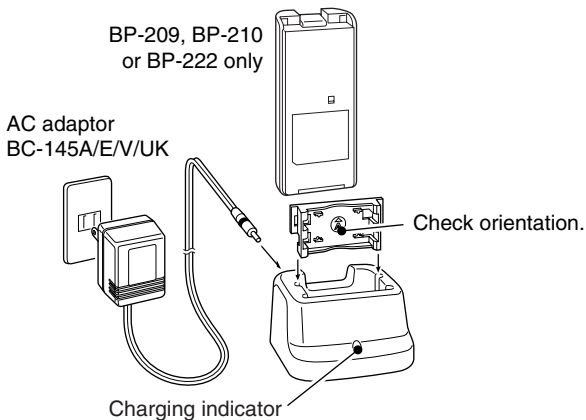

### ◇ Rapid charging with the BC-144+AD-99

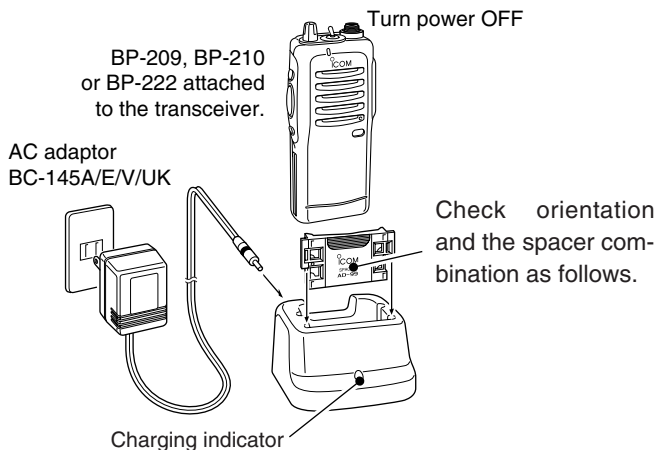

### ◇ Spacer combination.

- Be sure to attach the spacer (Spacer B/C) to the adaptor (Spacer A) with the orientation as illustrated in the diagram at right.
- Attach the spacer (Spacer B/C) to the adaptor with the orientation of the stamp “**C**” pointing up.

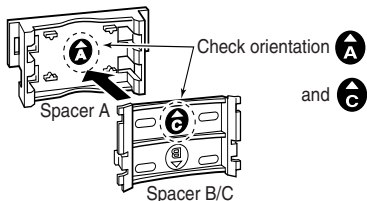

**NOTE:** Push the notch carefully when removing the spacer from the adaptor.

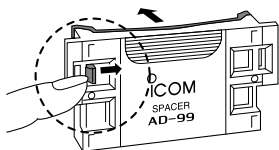

### 3 BATTERY PACKS

#### ◇ Rapid charging with the BC-121+AD-94 (#11)

The optional BC-121 allows up to 6 battery packs to be charged simultaneously. The following are additionally required.

- Six AD-94 (#11) (Some versions require additional AD-99s).
- An AC adaptor (may be supplied with the BC-121 depending on version).

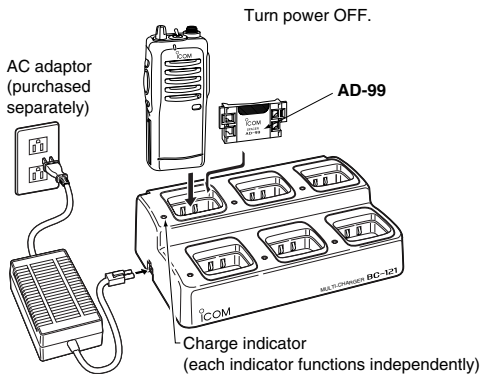

#### ◇ Regular charging with the BC-146

The optional BC-146 provides regular charging of optional battery pack with/without transceiver.

The following is additionally required:

- An optional AC adaptor. (A charging spacer is supplied with BC-146.)

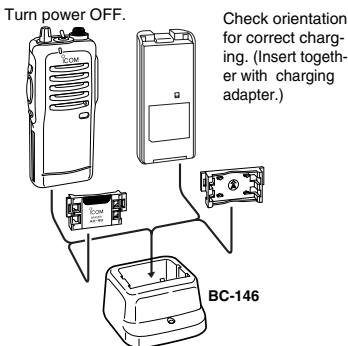



## ■ Charging NOTE

Prior to using the transceiver for the first time, the battery pack must be fully charged for optimum life and operation.

- Recommended temperature range for charging: +10°C to +40°C (50°F to 140°F).
- Use the supplied charger or optional charger (BC-119/BC-121/BC-144 for rapid charging, BC-146 for regular charging) only. **NEVER** use other manufacturers' chargers.

The optional BP-209, BP-210 or BP-222 battery packs include rechargeable Ni-Cd(Ni-MH: BP-210) batteries and can be charged approx. 300 times. Charge the battery pack before first operating the transceiver or when the battery pack becomes exhausted.

If you want to charge the battery pack more than 300 times, the following points should be observed:

- **Avoid overcharging**—batteries must be removed from the charger to stop charging. Batteries should not be charged for more than 20 hours after the LED indicator turns green.
- Use the battery until it becomes almost completely exhausted under normal conditions.

### ◇ Battery pack life

When the operating period becomes extremely short even after charging the battery pack fully, a new battery pack is needed.

**NOTE:** The charger rapidly charges a battery pack to a specified level, not a completed level, to prevent overcharging. Leave the battery pack in the charger for a few more hours (up to 15 hours; depending on battery condition) after the LED indicator turns green, to charge the battery completely.

### 3 BATTERY PACKS

## ■ Battery case (Option)

When using a BP-208 OPTIONAL BATTERY CASE attached to the transceiver, install 6 AA (R6) size alkaline batteries as illustrated below.

**NOTE:** Output power is automatically reduced to **1 W** to retain sufficient power in case of an emergency, etc.

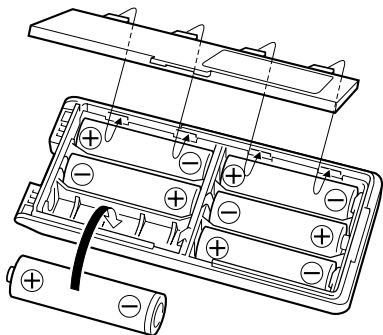

#### ◆ CAUTIONS

- Use **ALKALINE** batteries only.
  - **Make sure** all battery cells are the same brand, type and capacity.
  - **Never** mix old and new batteries.
- Either of the above may cause a fire hazard or damage the transceiver, if ignored.
- **Never** incinerate used battery cells since internal battery gas may cause them to rupture.
  - **Never** expose a detached battery case to water.
- If the battery case gets wet, be sure to wipe it dry before using it.

## ■ Set mode

Set mode is used for programming infrequently changed values or conditions of functions.

- All settings performed with [CH 1/CH 2], [OFF/VOL], [MONI], [PTT] and [W/N] keys.

### ◇ SETTING THE OPERATION FREQUENCY

The operating frequency can be selected from GMRS\* ( Plus 7 frequencies shared with FRS\*) and BRS frequencies. (pgs. 13–14 for IC-F11BR, pgs. 15–16 for IC-F21BR)

\* IC-F21BR (UHF model) only.

### ◇ SETTING THE CTCSS TONE FREQUENCY

CTCSS (Continuous Tone Coded Squelch System) encoder/decoder are standard, providing quiet stand-by. (pgs. 17–18)

### ◇ FREQUENCY FIND

This transceiver can detect the operating frequency by scanning the all pre-programmed channels. (p. 19)

### ◇ CTCSS FIND

This transceiver can detect the CTCSS tone frequency in the received signal. (p. 20)

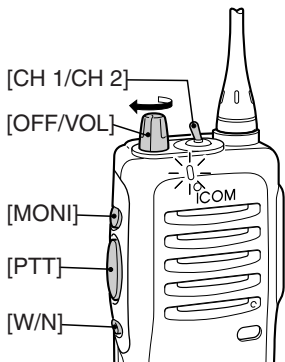

---

## 4 SET MODE

### ◆ IC-F11BR (VHF) SETTING THE OPERATION FREQUENCY

The operating frequency can be selected from 36 frequencies. (See right.) Select the frequencies you desire from the frequency table and assign them to CH 1 and CH 2.

• Default settings are as follows;

CH 1: Operating CH No. 1 (154.5700 MHz), CTCSS: No. 0 (OFF)

CH 2: Operating CH No. 2 (154.6000 MHz), CTCSS: No. 0 (OFF)

- ① While pushing and holding [PTT], [MONI] and [W/N], turn [OFF/VOL] to power ON.
- ② Select the desired CH 1 or CH 2 that you want to assign the frequency to.
- ③ Push and hold [W/N] until a beep (Pi) is emitted.
- ④ Push [PTT] the necessary number of times to choose the 10 digit of the desired channel from the channel list.
- ⑤ Push [MONI].
- ⑥ Push [PTT] the necessary number of times to choose the 1 digit of the desired channel from the frequency list.
- ⑦ Push [MONI].
- ⑧ Turn the power OFF, and then ON again.

### [Example]

To assign Frequency channel No. 28 as CH1;

- ① While pushing and holding [PTT], [MONI] and [W/N], turn [OFF/VOL] to power ON.
- ② Select the CH 1.
- ③ Push and hold [W/N] until a beep (Pi) is emitted.
- ④ Push [PTT] twice to choose the 10 digit of the desired channel.
- ⑤ Push [MONI].
- ⑥ Push [PTT] eight times to choose the 1 digit of the desired channel.
- ⑦ Push [MONI].
- ⑧ Turn the power OFF, and then ON again.

## • IC-F11BR Frequency channel list

No.	Freq.*	W/N	Note	No	Freq.*	W/N	Note
1	154.5700	N*1	Blue*2	.21	151.8800	N*1	MURS
2	154.6000	N*1	Green*2	22	151.8950	W	
3	151.5125	N*1		23	151.8950	N	
4	151.6250	W	Red	24	151.9250	W	
5	151.6250	N	Red	25	151.9250	N	
6	151.6550	W		26	151.9400	N*1	MURS
7	151.6550	N		27	151.9550	W	Purple
8	151.6850	W		28	151.9550	N	Purple
9	151.6850	N		29	154.4900	W	
10	151.7000	N*1		30	154.4900	N	
11	151.7150	W		31	154.5150	W	
12	151.7150	N		32	154.5150	N	
13	151.7600	N*1		33	154.5400	W	
14	151.7750	W		34	154.5400	N	
15	151.7750	N		35	158.4000	W	
16	151.8050	W		36	158.4000	N	
17	151.8050	N					
18	151.8200	N*1	MURS				
19	151.8350	W					
20	151.8350	N					

(Unit: MHz)

\*1: Fixed to N-FM mode. \*2: MURS

W/N: W-Wide FM, N-Narrow FM (default)

---

## 4 SET MODE

### ◆ IC-F21BR (UHF) SETTING THE OPERATION FREQUENCY

The operating frequency can be selected from GMRS ( Plus 7 frequencies shared with FRS) and BRS frequencies. (See right.)

Select the frequencies you desire from the frequency table and assign them to CH 1 and CH 2.

• Default settings are as follows;

CH 1: Operating CH No. 1 (464.5500 MHz), CTCSS: No. 0 (OFF)

CH 2: Operating CH No. 2 (467.9250 MHz), CTCSS: No. 0 (OFF)

- ① While pushing and holding [PTT], [MONI] and [W/N], turn [OFF/VOL] to power ON.
- ② Select the desired CH 1 or CH 2 that you want to assign the frequency to.
- ③ Push and hold [W/N] until a beep (Pi) is emitted.
- ④ Push [PTT] the necessary number of times to choose the 10 digit of the desired channel from the channel list.
- ⑤ Push [MONI].
- ⑥ Push [PTT] the necessary number of times to choose the 1 digit of the desired channel from the frequency list.
- ⑦ Push [MONI].
- ⑧ Turn the power OFF, and then ON again.

### [Example]

To assign Frequency channel No. 28 as CH1;

- ① While pushing and holding [PTT], [MONI] and [W/N], turn [OFF/VOL] to power ON.
- ② Select the CH 1.
- ③ Push and hold [W/N] until a beep (Pi) is emitted.
- ④ Push [PTT] twice to choose the 10 digit of the desired channel.
- ⑤ Push [MONI].
- ⑥ Push [PTT] eight times to choose the 1 digit of the desired channel.
- ⑦ Push [MONI].
- ⑧ Turn the power OFF, and then ON again.

## • IC-F21BR Frequency channel list

No.	Freq.*	W/N	Note	No	Freq.*	W/N	Note
1	464.5500	W	Yellow	21	462.8375	N*1	
2	467.9250	W	Blue Star	22	462.8625	N*1	
3	462.5500	N		23	462.8875	N*1	
4	462.5625	N	FRS*2	24	462.9125	N*1	
5	462.5750	N	White	25	464.3250	N	
6	462.5875	N	FRS*2	26	464.4875	N*1	
7	462.6000	N		27	464.5000	W	Brown
8	462.6125	N	FRS*2	28	464.8250	W	
9	462.6250	N	Black	29	467.7625	W	J
10	462.6375	N	FRS*2	30	467.8125	W	K
11	462.6500	N		31	467.8500	W	Siver Star
12	462.6625	N	FRS*2	32	467.8750	W	Gold Star
13	462.6750	N	Orange	33	467.9000	W	Red Star
14	462.6875	N	FRS*2	34	469.2625	W	
15	462.7000	N		35	469.5000	W	
16	462.7125	N	FRS*2	36	469.5500	W	
17	462.7250	N					
18	462.7625	N*1					
19	462.7875	N*1					
20	462.8125	N*1					

(Unit: MHz)

\*1: Fixed to N-FM mode. \*2: FRS channels shared with GMRS.

W/N: W-Wide FM, N-Narrow FM (default)

 : BRS channels,  ; GMRS channels

---

## 4 SET MODE

### ◆ SETTING THE CTCSS TONE FREQUENCY

This transceiver is equipped with 52 CTCSS codes. (See p. 18.) CTCSS operation provides communication with silent standby since you will only receive calls from group members using the same CTCSS number.

You can assign different numbers to CH 1 and CH 2 independently.

- ① While pushing and holding [PTT], [MONI], [W/N], turn [OFF/VOL] to power ON.
- ② Select the desired CH 1 or CH 2 that you want to assign the CTCSS tone frequency to .
- ③ Push and hold [MONI] until a beep (Pi) is emitted.
- ④ Push [PTT] the necessary number of times to choose the 10 digit of the desired channel from the channel list.
- ⑤ Push [MONI].
  - Confirmation beep is emitted (See p. 19)
- ⑥ Push [PTT] the necessary number of times to choose the 1 digit of the desired channel from the frequency list.
- ⑦ Push [MONI].
- ⑧ Turn the power OFF, and then ON again.

### [Example]

To assign code No. 28 as CH1;

- ① While pushing and holding [PTT], [MONI] and [W/N], turn [OFF/VOL] to power ON.
- ② Select the CH 1.
- ③ Push and hold [MONI] until a beep (Pi) is emitted.
- ④ Push [PTT] twice to choose the 10 digit of the desired channel.
- ⑤ Push [MONI].
- ⑥ Push [PTT] eight times to choose the 1 digit of the desired channel.
- ⑦ Push [MONI].
- ⑧ Turn the power OFF, and then ON again.



• CTCSS tone code list

No.	Freq.*	No.	Freq.*	No.	Freq.*	No.	Freq.*
0	OFF	16	107.2	32	171.3	48	233.6
1	67.0	17	110.9	33	173.8	49	241.8
2	69.3	18	114.8	34	177.3	50	250.3
3	71.0	19	118.8	35	179.9	51	254.1
4	71.9	20	123.0	36	183.5	52	270.4
5	74.4	21	127.3	37	186.2		
6	77.0	22	131.8	38	189.9		
7	79.7	23	136.5	39	192.8		
8	82.5	24	141.3	40	196.6		
9	85.4	25	146.2	41	199.5		
10	88.5	26	151.4	42	203.5		
11	91.5	27	156.7	43	205.5		
12	94.8	28	159.8	44	210.7		
13	97.4	29	162.2	45	218.1		
14	100.0	30	165.5	46	225.7		
15	103.5	31	167.9	47	229.1		

(Unit: Hz)

: EIA/TIA standard code (Recommended to use these.)

## 4 SET MODE

### ◆ SETTING THE CTCSS TONE FREQUENCY (continued)

- CTCSS confirmation beep

Push [PTT]	Confirmation beep	Push [PTT]	Confirmation beep
no	●	5 (Fifth)	●●●●●
1 (Once)	●	6 (Sixth)	▬ ●
2 (Twice)	●●	7 (Seventh)	▬ ●●
3 (Third)	●●●	8 (eighth)	▬ ●●●
4 (Fourth)	●●●●	9 (ninth)	▬ ●●●●

●; Single beep

▬ ; Long beep

### ◆ FREQUENCY FIND

This transceiver can detect the operating frequency by scanning all pre-programmed channels. Scan pauses when receiving the signal. You can assign that operating channel to your transceiver.

This function very useful when you are going to communicate with unknown channel number stations.

You can also find which CTCSS tone number is being used by them with the 'CTCSS FIND' function. (Next page)

- ① While pushing and holding [MONI], [W/N], turn [OFF/VOL] to power ON.
- ② Select the desired CH 1 or 2 that you want to assign the frequency.
- ③ Push and hold [W/N] until a beep (Pi) is emitted.
  - 'FREQUENCY FIND' start to scan the signal.
- ④ 'FREQUENCY FIND' stops when the signal is detected.
- ⑤ Push [W/N] to determine the frequency channel number.
- ⑥ Turn the power OFF, and then ON again.

**Note:** CTCSS tone setting turns to No. 0 (OFF) automatically after turn the power ON again.

**◇ CTCSS FIND**

This transceiver can detect the CTCSS tone frequency in the received signal. By monitoring a signal that is being transmitted from the other station, you can determine the tone frequency required to communicate with them.

This function very useful when you are going to communicate with unknown CTCSS channel number stations. 'CTCSS FIND' scans all of the CTCSS channels, then stops when a tone frequency is detected.

- ① While pushing and holding [MONI], [W/N], turn [OFF/VOL] to power ON.
- ② Select the desired CH 1 or CH 2 that you want to assign the CTCSS tone frequency.
- ③ Push and hold [MONI] until a beep (Pi) is emitted.
  - 'CTCSS FIND' start to scan the signal.
- ④ 'CTCSS FIND' stops when the tone signal is detected.
- ⑤ Push [MONI] to determine the tone number.
- ⑥ Turn the power OFF, and then ON again.

# 5 OPERATION

## ■ Receiving and transmitting

 **NOTE:** Transmitting without an antenna may damage the transceiver. See p.4 for antenna attachment.

 Turn power ON as described on p. 2.

 Program the operating frequency channel and CTCSS tone number (select CH 0 if you will not use the CTCSS function) before operation.

### ***Receiving:***

- ① Select the desired channel CH 1 or CH 2.
- ② Listen for a transmission and adjust [VOL] to a comfortable listening level.
  - When no transmission is heard, push and hold [MONI] while adjusting [VOL].

The transceiver is now set to receive desired calls on the selected channel.

### ***Transmitting:***

Wait for the channel to become clear to avoid interference.

- ③ While pushing and holding [PTT], speak into the microphone at a normal voice level.
- ④ Release [PTT] to return to receive.

**IMPORTANT:** To maximize the readability of your transmitted signal, pause a few sec. after pushing [PTT], hold the microphone 10 to 15 cm from your mouth and speak at a normal voice level.

**◇ MONITOR AUDIBLE FUNCTION**

The monitor function allows you to open the transceiver's squelch manually to check whether a channel is busy or not. The transceiver has 2 conditions for receive standby:

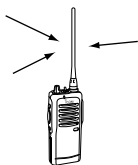

All signals are received

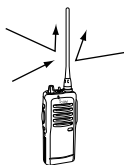

Only signals containing the proper tone are received

**Audible condition:**

This condition mutes audio ONLY when no carrier is present. You can receive (or monitor) any signals on a channel.

- Push and hold the [MONI], switch to select the audible condition.

Any audio mute functions are cancelled while pushing the [MONI] switch.

**Inaudible condition:**

This condition mutes ALL signals except those directed to you. Therefore you should check a channel's condition (busy or not) with the monitor function before transmitting.

- Push the [MONI] switch momentarily to select the inaudible condition.

**◇ TIME-OUT TIMER**

After continuous transmission for a pre-programmed period, the time-out timer is activated, causing the transceiver to stop transmitting and automatically selects receive.

- The time-out timer function is automatically turned ON when 3 min. has passed.

**◇ POWER SAVE FUNCTION**

The power save function reduces the current drain to conserve battery power.

- The power save function is automatically turned ON when no operation is performed or no signal is received for 5 sec.

---

## 5 OPERATION

### ■ Setting squelch level

The squelch circuit mutes the received audio signal depending on the signal strength. Scan proceeds in sequence from lower channel to higher channel numbers.

- ① While pushing [PTT] and [W/N], turn the transceiver's power on to enter the squelch adjustment mode.
- ② Push [MONI] to increase the squelch level (tight squelch) or [W/N] to decrease the squelch level (loose squelch).
  - Squelch level will be fixed after 1 sec.

### ■ Wide/Narrow selection

You can easily to toggle between wide FM mode and narrow FM mode by pushing [W/N] key.

- Push [W/N]: Turns to wide FM mode
- Pushing and holding [W/N]: Turns to narrow FM mode

**NOTE:** Some channels cannot toggle between wide FM and narrow FM. Please refer the Frequency channel list. (pgs. 14, 16)

## Options

### ◆ BATTERY PACKS

- **BP-208** BATTERY CASE

Allows a set of Alkaline batteries to operate the handheld when charging the rechargeable battery or in emergencies, etc. 6 AA (R6) cells are required.

- **BP-209** Ni-Cd BATTERY PACK

7.2 V/1100 mAh Ni-Cd battery pack, allows more than 8 hours operation.

- **BP-210** Ni-MH BATTERY PACK

7.2 V/1650 mAh Ni-MH battery pack, allows approx. 11 hours operation.

- **BP-222** Ni-Cd BATTERY PACK

7.2 V/600 mAh Ni-Cd battery pack, allows approx. 5.5\* hours operation (Same as supplied with 2 W models).

\*When used with 2 W model.

### ◆ CHARGER

- **BC-119** DESKTOP CHARGER + AD-99 (#11)

For rapid charging of battery packs. An AC adaptor is supplied with the charger. Charging time: 1.5 to 2 hrs.

- **BC-121** MULTI-CHARGER

For rapid charging up to 6 battery packs simultaneously. An AC adaptor may be supplied depending on version. Six AD-94s (#11) are necessary. Charging time: 1.5 to 2 hrs.

- **AD-99** CHARGER ADAPTOR

- **BC-144** DESKTOP CHARGER

For rapid charging of BP-209 (Ni-Cd), BP-210 (Ni-MH) and BP-222 (Ni-Cd).

- **BC-146** DESKTOP CHARGER

For regular charging of BP-209 (Ni-Cd), BP-210 (Ni-MH) and BP-222 (Ni-Cd).

---

## 6 OPTION

### ◇ OTHER OPTIONS

- **HM-46L/HM-75A/HM-131L** SPEAKER-MICROPHONE  
Combination speaker-microphone that provides convenient operation while hanging the transceiver from your belt.  
HM-75A has programmable function key Mic Up, Mic Down, Mic A, Mic B.  
HM-131L has a moisture proof construction.
- **HM-128L** EARPHONE-MICROPHONE
- **HS-51** HEAD SET  
Allows you hands-free operation. Includes PTT and TOT.
- **SP-13** EARPHONE  
Provides clear receive audio in noisy environments.
- **MB-68** BELT CLIP  
Same as that supplied with the transceiver.
- **MB-74** BELT CLIP  
Exclusive alligator-type belt clip.
- **FA-SC73US** STUBBY ANTENNAS  
Shorter UHF antennas: 450–470 MHz
- **AD-98FSC** antenna connector adaptor  
Allows you to connect a BNC-type antenna.



**Count on us!**

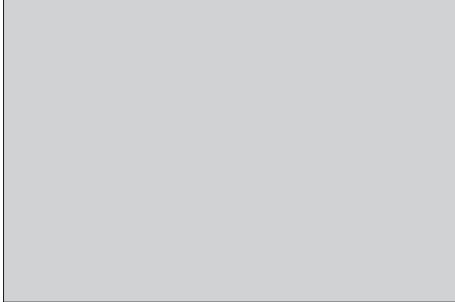

A-6036D-1BR  
Printed in Japan  
© 2001 Icom Inc.

**Icom Inc.**  
1-1-32 Kamiminami, Hirano-ku, Osaka 547-0003 Japan

---