



INSTRUCTION MANUAL

VHF TRANSCEIVER

IC-F310

IC-F320

UHF TRANSCEIVER

IC-F410

IC-F420

This device complies with Part 15 of the FCC Rules. Operation is subject to the condition that this device does not cause harmful interference.

**SmarTrunk II™
Compatible**

Icom Inc.

IMPORTANT

READ ALL INSTRUCTIONS carefully and completely before using the transceiver.

SAVE THIS INSTRUCTION MANUAL — This instruction manual contains important operating instructions for the **IC-F310, IC-F320, IC-F410** and **IC-F420 VHF/UHF TRANSCEIVERS**.

EXPLICIT DEFINITIONS

WORD	DEFINITION
⚠ WARNING	Personal injury, fire hazard or electric shock may occur.
CAUTION	Equipment damage may occur.
NOTE	If disregarded, inconvenience only. No risk of personal injury, fire or electric shock.

 Versions of the IC-F310/F320/F410/F420 which display “CE” on the serial number seal, comply with the essential requirements of the 89/336/EEC directive for Electromagnetic Compatibility.

CAUTIONS

⚠ WARNING! NEVER connect the transceiver to an AC outlet. This may pose a fire hazard or result in an electric shock.

NEVER connect the transceiver to a power source of more than 16 V DC such as a 24 V battery. This connection will ruin the transceiver.

NEVER cut the DC power cable between the DC plug and fuse holder. If an incorrect connection is made after cutting, the transceiver might be damaged.

NEVER place the transceiver where normal operation of the vehicle may be hindered or where it could cause bodily injury.

NEVER allow children to touch the transceiver.

NEVER expose the transceiver to rain, snow or any liquids.

USE supplied microphone only. Other microphones have different pin assignments and may damage the transceiver.

SmarTrunk II™ is a Trademark of SmarTrunk Systems, Inc.

TABLE OF CONTENTS

IMPORTANT	i
EXPLICIT DEFINITIONS	i
CAUTIONS	i
TABLE OF CONTENTS	ii
1 PANEL DESCRIPTION	1–5
■ Front panel	1
■ Function display	2
■ Programmable function keys	3
2 OPERATION	6–8
■ Turning power ON	6
■ Channel selection	6
■ Receiving and transmitting	7
◇ Transmitting notes	7
◇ Tx code channel selection	8
◇ Tx code number selection	8
◇ DTMF transmission	8
3 CONNECTION AND MAINTENANCE	9–12
■ Rear panel and connection	9
■ Unpacking	10
■ Mounting the transceiver.....	11
■ Optional UT-96/UT-105 installation	11
■ Optional OPC-617 installation	12
■ Antenna	12
■ Fuse replacement	12
■ Cleaning	12
4 OPTIONAL SmarTrunk II™ OPERATION	13–15
■ SmarTrunk II™ and conventional modes	13
■ SmarTrunk II™ operation	13
5 OPTIONS	16

DO NOT use or place the transceiver in areas with temperatures below -30°C or above $+60^{\circ}\text{C}$ or, in areas subject to direct sunlight, such as the dashboard.

AVOID operate the transceiver without running the vehicle's engine. The vehicle's battery will quickly run out if the transceiver is in transmission while the vehicle's engine OFF.

AVOID placing the transceiver in excessively dusty environments.

AVOID placing the transceiver against walls. This will obstruct heat dissipation.

AVOID the use of chemical agents such as benzine or alcohol when cleaning, as they damage the transceiver surfaces.

BE CAREFUL! The transceiver will become hot when operating continuously for long periods.

For U.S.A. only

CAUTION: Changes or modifications to this transceiver, not expressly approved by Icom Inc., could void your authority to operate this transceiver under FCC regulations.

1

PANEL DESCRIPTION

■ Front panel

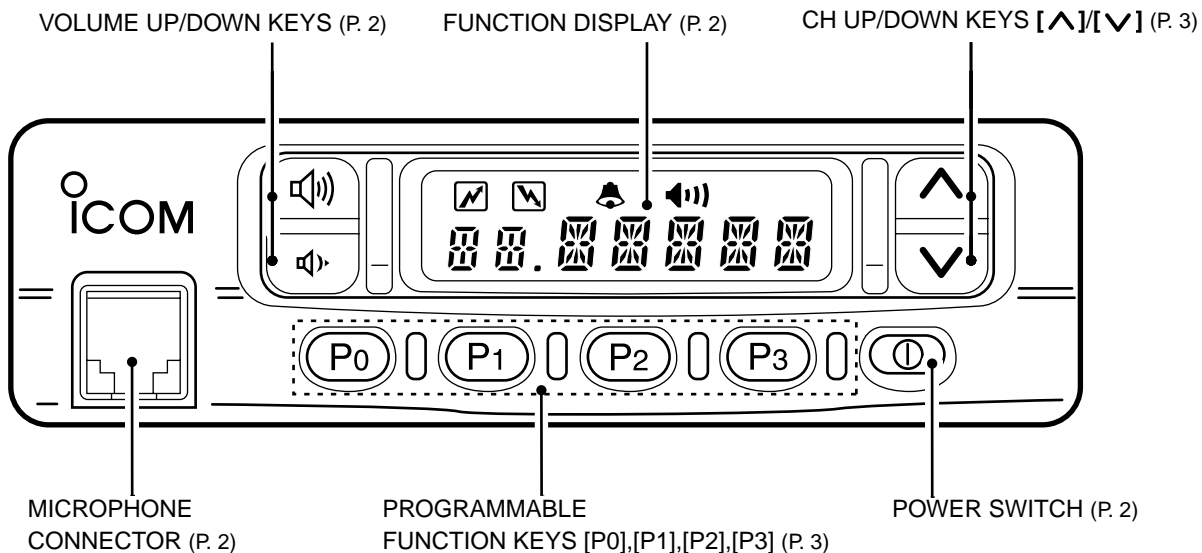

VOLUME UP/ DOWN KEYS

Push to adjust the audio output level.

- Minimum audio level is pre-programmed.

CH UP/DOWN [^] [v] KEYS

- Push to select the operating channel.
- Can be programmed for one of several functions by your dealer.

POWER SWITCH

Turns the power ON and OFF.

- The following functions are available at power ON as options:
 - Automatic scan start
 - Password prompt

MICROPHONE CONNECTOR

Connect the supplied microphone or optional DTMF microphone for SmarTrunk II™ operation here.

NEVER connect other microphones. The pin assignments may be different and the transceiver may be damaged.

MICROPHONE

The supplied microphone has a PTT switch and a hanger hook.

- The following functions are available when the microphone is on or off hook:
 - Automatic scan start when hung on.
 - Automatic priority channel selection when off.
 - Sets to 'Inaudible' condition (mute condition) when hung on.
 - Sets to 'Audible' condition (unmute condition) when off.

■ Function display

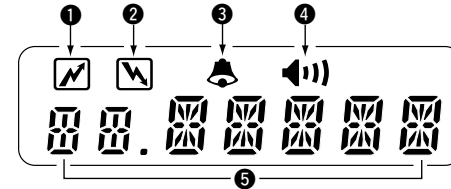

❶ TRANSMIT INDICATOR

- Appears while transmitting or sending a 5-tone code.
- When internal temperature increases to a specific level, the transmit indicator blinks to indicate that the power down circuit has been activated.

❷ BUSY INDICATOR

Appears while the channel is busy.

❸ BELL INDICATOR

Appears or blinks when the specified 5-tone call is received.

❹ AUDIBLE INDICATOR

Appears when the channel is in the 'Audible' condition (unmute condition).

❺ ALPHANUMERIC DISPLAY

NOTE: When the alphanumeric display blinks transmitting becomes impossible. In this case check that the antenna is not mis-matched or that DC battery voltage has not dropped below 8 V.

1 PANEL DESCRIPTION

■ Programmable function keys

The following functions can be assigned to **[P0]**, **[P1]**, **[P2]**, **[P3]**, **[^]** and **[v]** programmable function keys.

Consult your Icom Dealer or System operator for details concerning your transceivers programming.

In the following explanations, programmable function names are bracketed, the specific switch used to activate the function depends on programming.

CH UP CH UP AND DOWN KEYS

- Select an operating channel.

CH DN

- Select a transmit code channel after pushing the **[TX CH]** key.
- Select a DTMF channel after pushing the **[DTMF]** key.
- Select a scan group after pushing and holding the **[SCAN]** key.

CH 1 OPERATING CHANNEL KEYS

CH 2 Select an operating channel directly.

CH 3

CH 4

PRI A

PRIORITY CHANNEL KEYS

Select priority A or priority B channel with each push.

PRI B

BANK

BANK KEY

Select a bank (a group of 16 channels).

- When the optional UT-105 is installed, push one or more times to select a channel bank for conventional channels or SmarTrunk II™ channels.

SCAN

SCAN START/STOP KEY

Push this key to start scanning; and push again to stop.

 **NOTE:** Place the microphone on hook to start scanning.
Take the microphone off hook to stop scanning.

Push and hold this key to indicate the scan group, then push to select the desired group.

TAG

SCAN TAG KEY

Adds or deletes the selected channel to the scan group.

BEEP

BEEP

Push to turn the beep tones ON/OFF.

LOCK

LOCK KEY

Electronically locks all programmable keys except the following:

- **[CALL]** (incl. CAL A and CAL B), **[MONI]** and **[EMER]** keys.

MONI

MONITOR KEY

Activates one of (or two of) the following functions on each channel independently:

- Push and hold the key to unmute the channel (audio is emitted; 'Audible' condition).
- Push the key to toggle the mute and unmute conditions (toggles 'Audible' and 'Inaudible').
- Push the key to mute the channel (sets to 'Inaudible' only).
- Push the key to unmute the channel (sets to 'Audible' only).
- Push the key after the communication is finished to send a 'reset code'.

NOTE: The unmute condition ('Audible' condition) may automatically return to the mute condition ('Inaudible' condition) after a specified period.

WIDE/NARROW KEY

W/N

Push **[W/N]** to toggle bandwidth between wide or narrow.

- This function is available for W/N versions only.

HIGH

OUTPUT POWER SELECTION KEYS

Select the transmit output power temporarily or permanently depending on the pre-setting.

LOW1

LOW2

- Ask your Dealer or System Operator for the output power level for each selection.

T A

TALK AROUND KEY

Turns the talk around function ON and OFF.

- The talk around function equalizes the transmit frequency to the receive frequency for mobile-to-mobile communication.

CALL

CALL KEYS

Transmit a 5-tone call.

CAL A

CAL B

- Call transmission is necessary before you call another station depending on your signaling system.
- The **[CAL A]** and/or **[CAL B]** keys may be available when your system employs selective 'Individual/Group' calls. Ask your System Operator which call is assigned to each key.

EMER

EMERGENCY KEY

Push and hold the key to transmit an emergency call.

- If you want to cancel the emergency call, push (or push and hold) the key again before transmitting the call.
- The emergency call is transmitted one time only or repeatedly until receiving a control code depending on the pre-setting.

1 PANEL DESCRIPTION

TX CH TX CODE KEY

Select a transmit 5-tone code (station code) channel.

- Push and hold to changes the contents of the station code using [**^**]/[**v**] keys.
- Push to selects a TX 5-tone code channel using [**^**]/[**v**] keys after pushing this key.

CODE TX CODE CHANNEL UP/DOWN KEY

Push to selects a TX code channel directory.

DTMF DTMF CHANNEL SELECT KEY

Push this key to select a DTMF channel.

- Push this key, then select the desired DTMF channel using the [**^**]/[**v**] keys.

Push and hold this key to transmit the selected DTMF code.

NOTE: DTMF channels 6 and 7 are used for ID code and emergency code respectively, depending on your system set up.

Ask your System Operator or Dealer about DTMF channels 6 and 7 before using these.

TO NE C. TONE CHANNEL ENTER KEY

Push this key then input a continuous tone memory channel number via the keypad to change the tone frequency.

ID MR ID MEMORY READ KEY

Recalls detected ID codes.

- Push this key, then push [**^**]/[**v**] for selection.
 - Up to 5 ID's are memorized.
- Push and hold this key to erase all memorized IDs.

LITE LIGHT

Push to select the backlight condition.

ON :Turns ON the backlight continuously.

OFF :Turns OFF the backlight.

AUTO :Turns ON/OFF depending on the ACC socket pin 1 voltage.

ON: Low (0 V) OFF: High (12 V)

ATT ATTENUATOR

Push to turn the attenuator function ON/OFF.

NOTE: The attenuator function protects desired signals from distorting when excessively strong signals, such as broadcast, pager signals, etc. are nearby.

GRP TRUNKING GROUP SWITCH

Push to select the Trunking group.

■ Turning power ON

① Push [①] to turn the power ON.

- A power-up alert tone sounds for about 1 sec. and an opening message may appear.

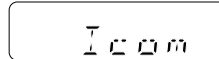

Opening message may differ depending on the pre-setting.

② If the transceiver is programmed for a start up passcode, input start up passcode as directed by your System operator.

- The keys in the diagram below can be used for password input:

The transceiver detects numbers in the same block as identical. Therefore "1234" and "6789" are the same.

KEY	P0	P1	P2	P3	▽
NUMBER	0 5	1 6	2 7	3 8	4 9

③ When the "PWORD" indication does not clear after inputting 4 digits, the input code number may be incorrect. Turn power off and start over in this case.

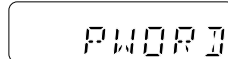

Input your password if this display appears.

■ Channel selection

Several types are available, and the channel selection method may differ according to your system set up.

NON-BANK TYPE:

Push the [^]/[v] keys to select the desired operating channel, in sequence; or, push one of the [CH 1] to [CH 4] keys to select these channels directly.

BANK-TYPE:

Push [BANK] to select the desired bank number.

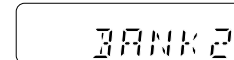

AUTOMATIC SCAN TYPE:

Channel setting is not necessary for this type. When turning the power ON, the transceiver automatically starts scanning. Scanning stops when receiving a call or when taking the microphone off hook.

2 OPERATION

■ Receiving and transmitting

RECEIVING:

- ① Push [①] to turn the power ON.
- ② Push [^]/[v] to select a channel.
- ③ When receiving a call, adjust the volume [UP] or [DOWN] to a comfortable listening level.

TRANSMITTING:

- ④ Take the microphone off hook.
 - 5-tone mute may be released (the 'audible' condition is selected and "◀||)" appears).
 - A priority channel may be selected automatically.
- ⑤ Wait for the channel to become clear.
 - The channel is busy when "N" appears.
- ⑥ Push the [CALL] key when initiating a call from your side.
 - Coded audio may be heard from the transceiver, then "◀||)" appears.
 - This operation may not be necessary depending on your signaling system. Ask your System Operator or Dealer.
- ⑦ While pushing and holding [PTT], speak into the microphone at your normal voice level.
- ⑧ Release [PTT] to receive.

 **IMPORTANT:** To maximize the readability of your signal: (1) pause briefly after pushing [PTT], (2) hold the transceiver 15 to 20 cm from your mouth, then speak into the microphone at a normal voice level.

◇ Transmitting notes

• Transmit inhibit function

The transceiver has several lockout/inhibit functions which restrict transmission under the following conditions:

- The channel is in mute condition ('Inaudible' condition; "◀||)" does not appear).
- Channel is busy.
- No matched (or matched) CTCSS is received.
- The selected channel is a 'receive only' channel.

• Time-out timer

After continuous transmission for a pre-programmed period, the time-out timer is activated causing the transceiver to stop transmitting and automatically select receive.

• Penalty timer

Once the time-out timer is activated, transmission is further inhibited for a period determined by the penalty timer.

◇ Tx code channel selection

If the transceiver has a [TX CH] key, display can be toggled between the operating channel number (or name) and Tx code channel number (or name). When the Tx code channel number (or name) is displayed, the [▲]/[▼] keys select the Tx code channel.

TO SELECT A TX CHANNEL:

- ① Push [TX CH] — a Tx code channel appears.
- ② Push [▲]/[▼] to select the desired Tx code channel.
- ③ Push [CALL] to transmit the selected Tx code.
- ④ Push [TX CH] again to return to the channel display.

◇ Tx code number selection

If the transceiver has a [CODE] key, Tx code contents can be changed within the allowable digits.

TO SELECT A TX CODE:

- ① Push [CODE] — a Tx code number appears and an allowable digit blinks.
- ② Push [▲]/[▼] to select the desired number at the blinking digit.
- ③ Push [CODE] to enter the selected number.
- ④ Repeat steps ② and ③ to input all allowed digits.
- ⑤ Push [CALL] to transmit the selected Tx code.

◇ DTMF transmission

If the transceiver has a [DTMF] key, the automatic DTMF transmission function is available. Up to 7 DTMF channels may be available.

- ① Push [DTMF] to select the display as at right.
- ② Push [▲]/[▼] to select the desired DTMF channel.
- ③ Push and hold [DTMF] to transmit the DTMF code on the selected DTMF channel.

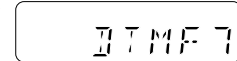

3

CONNECTION AND MAINTENANCE

■ Rear panel and connection

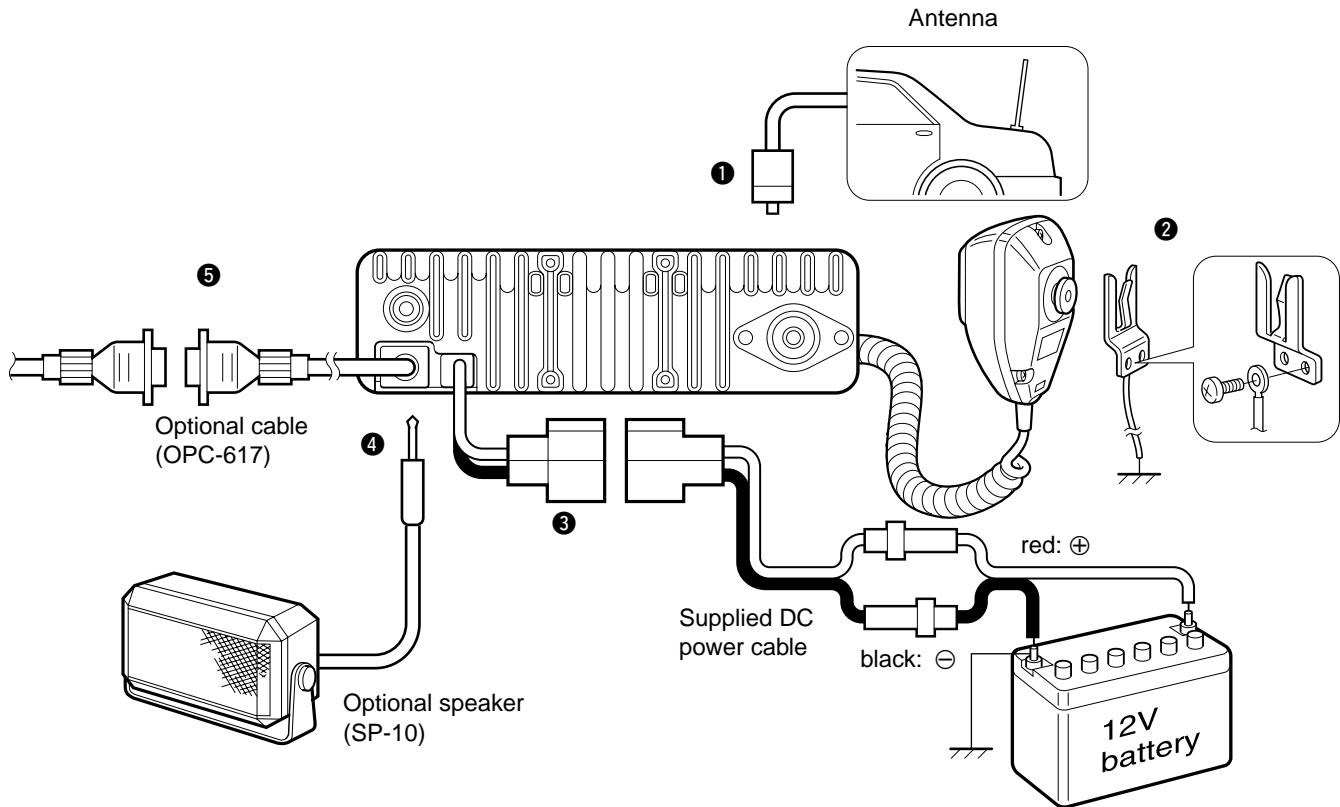

1 ANTENNA CONNECTOR

Connects to an antenna. Ask your Dealer about antenna selection and placement. (See p. 12)

2 MICROPHONE HANGER

Connect the supplied microphone hanger to the vehicle's ground for on/off hook microphone functions. (See p. 2)

3 DC POWER RECEPTACLE

Connects to a 12 V DC battery. Pay attention to polarities. **NEVER** connect to a 24 V battery. This could damage the transceiver.

4 EXTERNAL SPEAKER JACK

Connect a 4–8 Ω external speaker, if desired.

5 OPTIONAL CABLE (OPC-617)

Connect an external modem unit, LCD backlight control, etc.

Supplied Accessories

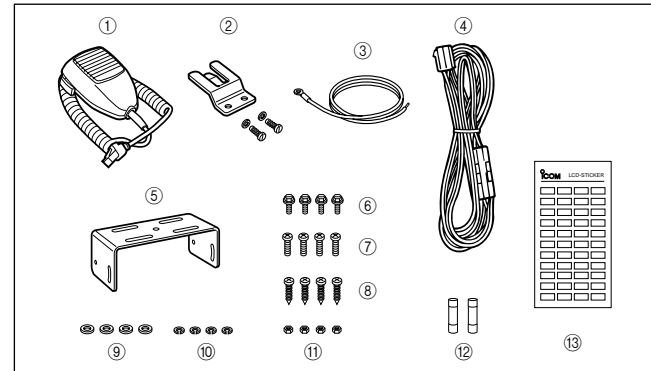

- | | |
|---|--|
| ① Microphone 1
(Some versions may not be supplied with a microphone) | ⑦ Mounting screw (M5×12) ... 4 |
| ② Microphone hanger and screw set 1 set | ⑧ Self-tapping screw (M5×20) 4 |
| ③ Microphone hanger cable . 1 | ⑨ Flat washer 4 |
| ④ DC power cable1
IC-F310/F410: OPC-345
IC-F320/F420: OPC-346 | ⑩ Spring washer 4 |
| ⑤ Mounting bracket 1 | ⑪ Nut 4 |
| ⑥ Bracket bolt 4 | ⑫ Fuse 2
IC-F310/F410: 15 A
IC-F320/F420: 20 A |
| | ⑬ Function name stickers*
(1705 LCD SEAL(A))1 |

◇ *Function name stickers

There are no names on the programmable function keys since the needed functions can be assigned to these keys. Attach the supplied function name stickers above the appropriate keys.

3 CONNECTION AND MAINTENANCE

■ Mounting the transceiver

The universal mounting bracket supplied with your transceiver allows overhead mounting. Please read the following instructions carefully.

- Mount the transceiver securely with the 4 supplied screws to a thick surface which can support more than 1.5 kg.

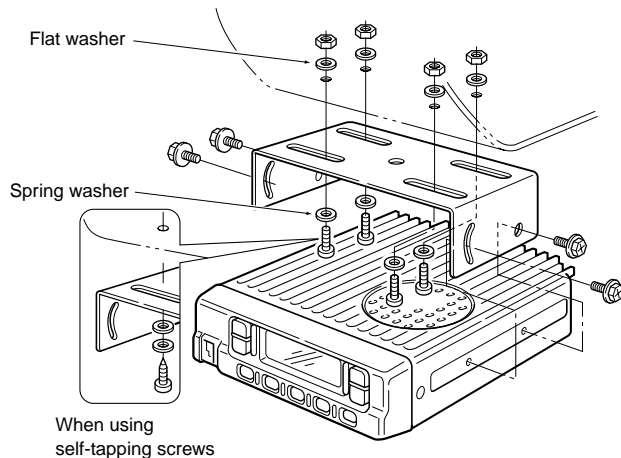

■ Optional UT-96/UT-105 installation

The optional UT-96/UT-105 units install as follows:

- ① Turn power OFF, then disconnect the DC power cable.
- ② Unscrew the 4 screws, then remove the bottom cover.
- ③ Install the unit as shown in the diagram below.
- ④ Replace the bottom cover and screws, then the DC power cable.

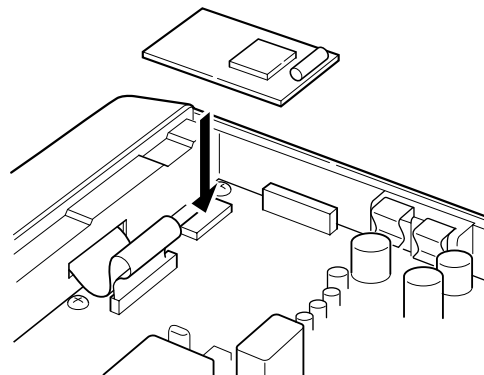

/// **NOTE:** The sponge supplied with the UT-105 is for the IC-F30/F40 series transceivers only.

Optional OPC-617 installation

Install the OPC-617 as shown below.

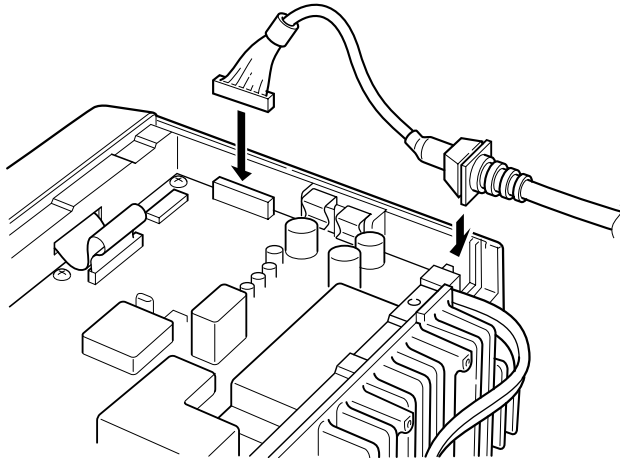

OPTIONAL CABLE PIN ASSIGNMENT

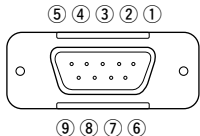

- | | |
|------------------------|------------------------|
| ① LCD backlit cont. IN | ⑥ Horn drive cont. OUT |
| ② AF OUT | ⑦ AF GND |
| ③ Det. AF OUT | ⑧ Det. AF GND |
| ④ Mod. IN | ⑨ Mod. GND |
| ⑤ PTT control IN | |

Antenna

A key element in the performance of any communication system is an antenna. Ask your Dealer about antennas and the best places to mount them.

Fuse replacement

Two fuses are installed in the supplied DC power cable. If a fuse blows or the transceiver stops functioning, track down the source of the problem, if possible, and replace the damaged fuse with a new, rated one.

□ Fuse rating IC-F310/F410: 15 A, IC-F320/F420: 20 A

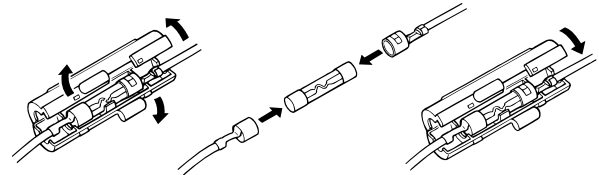

Cleaning

If the transceiver becomes dusty or dirty, wipe it clean with a dry, soft cloth.



AVOID the use of solvents such as benzene or alcohol, as they may damage transceiver surfaces.

■ SmarTrunk II™ and conventional modes

This transceiver is capable of SmarTrunk II™ functions.

The optional UT-105 allows communication in conventional channels or SmarTrunk II™ channels. Select a channel bank for SmarTrunk II™ before trunking operation.

- Push [**BANK**] one or more times to select a channel bank for conventional channels or SmarTrunk II™ channels.
- Scanning starts when a channel bank for SmarTrunk II™ is selected.
- Contact your Dealer for channel bank details.

 **NOTE:** Connect an optional HM-100T DTMF MICROPHONE. Contact your Dealer for details.

■ SmarTrunk II™ operation

These features are enabled by a Dealer or System Operator and may not be available in your system. Contact your Dealer for details.

◇ Placing a telephone call

Enter the phone number followed by [1], [*].

- A high-pitched beep indicates that the number is accepted.
- When the called party answers, push the [PTT] switch to talk, and release it to listen.

◇ Calling another local system subscriber

Enter the subscriber number followed by [3], [*].

- A high-pitched beep indicates that the number is accepted.
- You hear ringing, then two short beeps when the subscriber answers.
- If the other subscriber is on another call or out of range, you hear a fast busy signal and the call terminates automatically.

◇ Receiving a call

When you hear ringing, push [*] to answer.

- For a group call, you hear a short ring followed by two short beeps. You do not have to answer a group call to hear it over the air.

◇ Terminating a call

After completing a call, push [#] to disconnect (hang up).

 **IMPORTANT:** If one person in the conversation terminates a call, all participants will be cut off.

◇ Last number redial

Push [*], [*] to automatically redial the last number called.

- A high-pitched beep indicates that the number is accepted.

◇ Memory speed-dialing

To automatically dial a commonly used number from memory:

- Push [*] followed by the memory location (0–9).

◇ Turbo Speedial

To automatically dial a commonly used number with one push:

- Push one of the turbo Speedials ([A], [B], [C] or [D]).

◇ Programming memory speed dial

- ① Push and hold [*] until you hear a high-pitched beep.
- ② Enter the memory location (0–9, A, B, C, D), the telephone or subscriber number, then [1], [*] (or [3], [*] if for another system subscriber).
 - A high-pitched beep indicates successful programming.
 - Memories [A]–[D] are used for the Turbo Speedial.

◇ System busy indication

If all channels are busy, three low beeps sound after you initiate a call. Try the call again later.

◇ PTT dispatch operation

- ① Push [PTT] once (without dialing) to initiate a dispatch call.
- ② Begin talking after you hear three beeps (one short, high-pitched, two very-short, low-pitched).
- ③ Receiving a dispatch call is indicated by the same three-beep sequence.
 - It is not necessary to push [*] to answer a dispatch call.

◇ Emergency call

Push [0], [*] to initiate an emergency call.

- Contact your dealer for details.

4 OPTIONAL SmarTrunk II™ OPERATION

◇ Clear channel alerting

If all channels are busy, the transceiver automatically begins searching for an open channel and beeps every ten seconds. When two short beeps (low-pitched, then high-pitched) are heard, a channel is available. Push [*], [*] immediately to redial the last number.

 **NOTE:** For additional operating instructions, contact your Dealer or System Operator.

EXTERNAL SPEAKERS

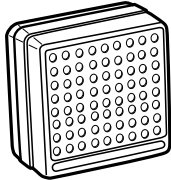

SP-5

Large speaker for good audio quality.

Input impedance: 4 Ω

Max. input power: 5 W

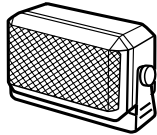

SP-10

Compact and easy-to-install.

Input impedance: 4 Ω

Max. input power: 5 W



HM-100T/TA

DTMF microphone.

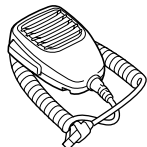

HM-100

Normal microphone.

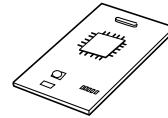

UT-96 5-TONE UNIT

Provides 2-tone/5-tone signaling .

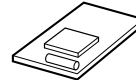

UT-105 SmarTrunk II™ Logic Board

Provides SmarTrunk II™ capabilities.

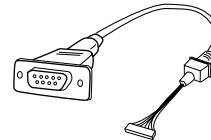

OPC-617 ACC CABLE

Allows you to connect to an external terminal.

Count on us!

A-5458D-1EX-③
Printed in Japan
© 1997 by Icom Inc.

Icom Inc.

6-9-16 Kamihigashi, Hirano-ku, Osaka 547-0002 Japan